

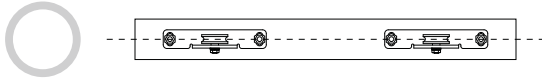

[Important Precautions] NSC series Sliding Door Closer

 Make sure that the hangers are mounted parallel / lined straight.

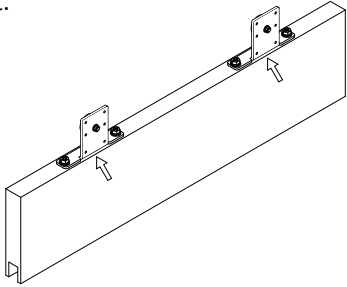
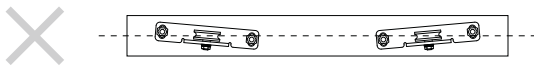

(Top View)



 Make sure that you hang the door **WITHOUT** mounting the Control Device (damper unit).

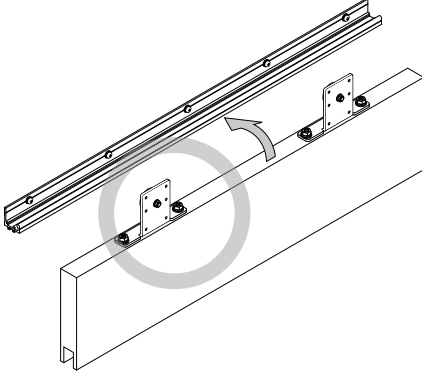

 Do NOT hang the door with the Control Device mounted. (Otherwise, may hit the rail and cause damage against the Control Device.)

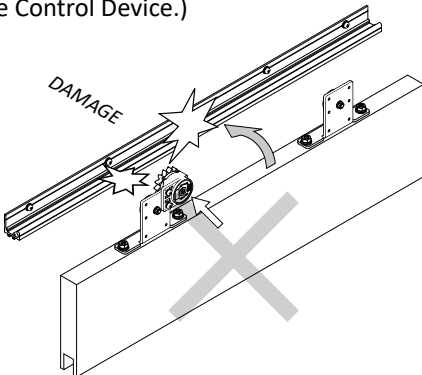

 In order to avoid the door to swing, provide suitable floor guide.

(Or you may purchase an option guide roller from us.)

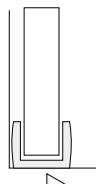

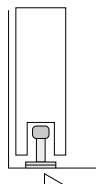

Floor Guide
(Prepared by customer)



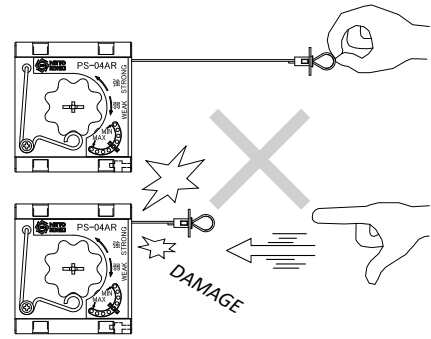

Guide Roller
(Available as option.)

 Do NOT release the wire of Pull Spring Device.

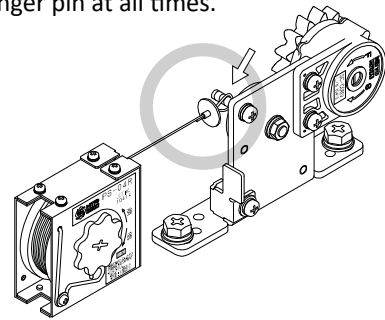

 Make sure that the wire is securely hooked on the hanger pin at all times.



 If necessary, provide a floor stop at the door closing side to relax the impact of closing.

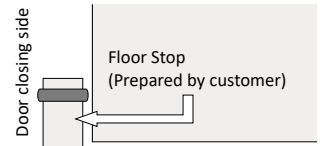

(Or you may purchase an additional door stop assembly available as option.)

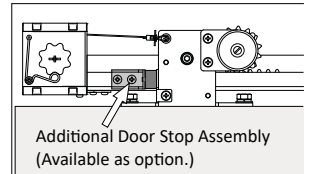

 Make sure that the door is not in contact with frame/wall.

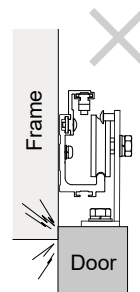

 Make sure that the door hangs straight and upright.

